



DEPARTMENT OF REGULATORY AND ECONOMIC RESOURCES (RER)  
BOARD AND CODE ADMINISTRATION DIVISION

MIAMI-DADE COUNTY  
PRODUCT CONTROL SECTION  
11805 SW 26 Street, Room 208  
Miami, Florida 33175-2474  
T (786) 315-2590 F (786) 315-2599  
[www.miamidade.gov/economy](http://www.miamidade.gov/economy)

## NOTICE OF ACCEPTANCE (NOA)

O'Hagin Manufacturing, LLC  
210 Classic Court, Suite #100  
Rohnert Park, CA 94928

### SCOPE:

This NOA is being issued under the applicable rules and regulations governing the use of construction materials. The documentation submitted has been reviewed and accepted by Miami-Dade County RER - Product Control Section to be used in Miami-Dade County and other areas where allowed by the Authority Having Jurisdiction (AHJ).

This NOA shall not be valid after the expiration date stated below. The Miami-Dade County Product Control Section (In Miami-Dade County) and/or the AHJ (in areas other than Miami-Dade County) reserve the right to have this product or material tested for quality assurance purposes. If this product or material fails to perform in the accepted manner, the manufacturer will incur the expense of such testing and the AHJ may immediately revoke, modify, or suspend the use of such product or material within their jurisdiction. RER reserves the right to revoke this acceptance, if it is determined by Miami-Dade County Product Control Section that this product or material fails to meet the requirements of the applicable building code.

This product is approved as described herein, and has been designed to comply with the Florida Building Code including the High Velocity Hurricane Zone of the Florida Building Code.

### DESCRIPTION: O'Hagin's Cloaked Vent Tile

**LABELING:** Each unit shall bear a permanent label with the manufacturer's name or logo, city, state and following statement: "Miami-Dade County Product Control Approved", unless otherwise noted herein.

**RENEWAL** of this NOA shall be considered after a renewal application has been filed and there has been no change in the applicable building code negatively affecting the performance of this product.

**TERMINATION** of this NOA will occur after the expiration date or if there has been a revision or change in the materials, use, and/or manufacture of the product or process. Misuse of this NOA as an endorsement of any product, for sales, advertising or any other purposes shall automatically terminate this NOA. Failure to comply with any section of this NOA shall be cause for termination and removal of NOA.

**ADVERTISEMENT:** The NOA number preceded by the words Miami-Dade County, Florida, and followed by the expiration date may be displayed in advertising literature. If any portion of the NOA is displayed, then it shall be done in its entirety.

**INSPECTION:** A copy of this entire NOA shall be provided to the user by the manufacturer or its distributors and shall be available for inspection at the job site at the request of the Building Official.

This NOA renews NOA# 19-0109.02 and consists of pages 1 through 9.  
The submitted documentation was reviewed by Alex Tigera.

03/14/24



NOA No.: 24-0220.03  
Expiration Date: 04/04/29  
Approval Date: 03/14/24  
Page 1 of 9

## ROOFING COMPONENT APPROVAL

**Category:** Roofing  
**Sub-Category:** Ventilation  
**Material:** 26ga. Steel; 0.032" Aluminum; 16 oz. Copper  
**Minimum Slope:** 2:12

## TRADE NAMES OF PRODUCTS MANUFACTURED OR LABELED BY APPLICANT

<u>Product</u>	<u>Dimensions</u>	<u>Test Specification</u>	<u>Product Description</u>
O'Hagin's Cloaked Vent Tile S-Profile	26" x 19 <sup>3</sup> / <sub>4</sub> " x 3 <sup>3</sup> / <sub>4</sub> "	TAS 100	Metal roof vent for tile roofs
O'Hagin's Cloaked Vent Tile M-Profile	25 <sup>1</sup> / <sub>2</sub> " x 19 <sup>1</sup> / <sub>4</sub> " x 2 <sup>5</sup> / <sub>8</sub> "	TAS 100	Metal roof vent for tile roofs
O'Hagin's Cloaked Vent Tile Flat-Profile	29" x 19" x 2"	TAS 100	Metal roof vent for tile roofs
Primary Vent - Standard Flange	24" x 11" x <sup>1</sup> / <sub>2</sub> "	TAS 100	Primary metal vent flashing for Flat, M, and S Profile vents
Primary Vent - Diverter Flange	24" x 11" x <sup>1</sup> / <sub>2</sub> "	TAS 100	Primary metal vent flashing with a diverter for Flat, M, and S Profile vents

## MANUFACTURING LOCATION

1. Rohnert Park, CA
2. Lakeland, FL

## EVIDENCE SUBMITTED

<u>Test Agency/Identifier</u>	<u>Name</u>	<u>Report</u>	<u>Date</u>
PRI Construction Materials Technologies	TAS 100(A)	OHI-025-02-01	01/10/08
	TAS 100(A)	OHI-014-02-02	12/08/07
	TAS 100(A)	OHI-026-02-01	01/10/08
	ASTM G 155	OHI-043-02-01	06/04/2018
	ASTM B 117	OHI-043-02-01	06/04/2018
	TAS 100 (A)	OHI-046-02-01	12/18/2018
	TAS 100 (A)	OHI-048-02-01	12/17/2018
	TAS 100 (A)	OHI-047-02-02	12/19/2018



NOA No.: 24-0220.03  
Expiration Date: 04/04/29  
Approval Date: 03/14/24  
Page 2 of 9



---

## APPROVED APPLICATIONS:

**Trade Name:** O'Hagin's Cloaked Vent Tile

**System Type A:** Mechanical attachment of vent under tile.

**Slot:** Mark a 19" x 7" (48.26 x 17.78cm) opening centered between layout lines and aligned approximately as shown on exposure lines as seen in Detail A. Set blade to thickness of sheathing and cut opening. Brush away sawdust and debris.

**Installation:** Set primary vent (with or without diverter) in a 1/8" (3.18mm) bed of asphalt roofing cement. Secure primary vent to the roof deck with 1-1/4" x 3/8" (31.75 x 9.53mm) galvanized ring shank roofing nails spaced 4" (10.16cm) o.c. Seal nails with an approved ASTM D 4586 roofing cement, sealing primary vent flange with a layer of Perma glass mesh buttered into the roof cement around the flange.

The tile vent can now be centered over the primary vent and nailed at the head with 2 ea. 1-1/4" x 3/8" (31.75 x 9.53mm) galvanized ring shank roofing nails. See Detail A.

**Ventilation Calculations:** See manufacturer's published literature for net free area

## LIMITATIONS:

1. Refer to applicable Building Code required ventilation.
2. The installation shall be applied in compliance with the manufacturer's current published application instruction and the requirements set forth in applicable building code.
3. Wind Clip hooks shall be fully engaged under head of preceding tiles.
4. O'Hagin's Cloaked vent tile may be installed on roofs up to roof mean heights of 40 ft.
5. All products listed herein shall have a quality assurance audit in accordance with the Florida Building Code and Rule 61G20-3 of the Florida Administrative Code.



## DETAIL A

### PRIMARY VENT (WITH OR WITHOUT DIVERTER FLANGE) INSTALLATION

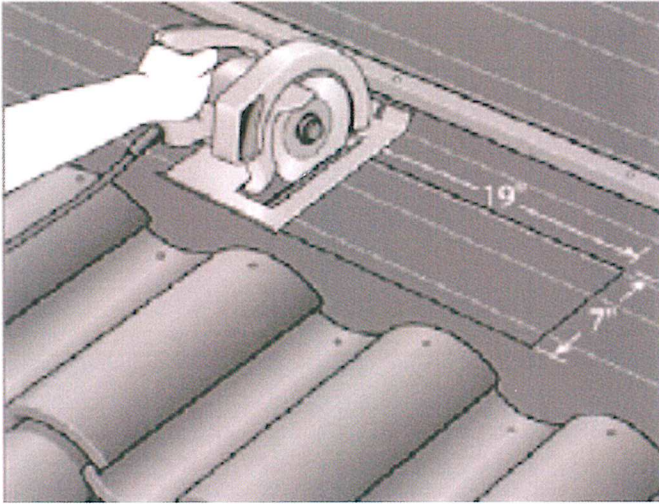

1. Mark and cut a 19" x 7" hole in the roof deck Centered between layout lines and aligned Approximately as shown on the exposure lines. (Set blade to the thickness of the sheathing)

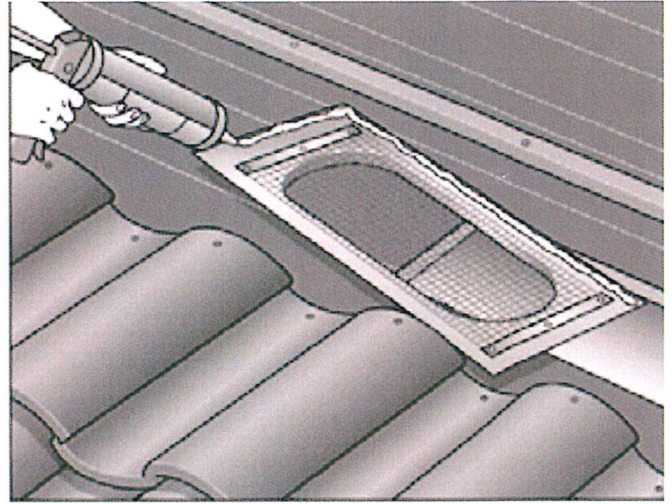

2. Seal using sufficient amount of locally approved sealant around outer flange of Primary vent.

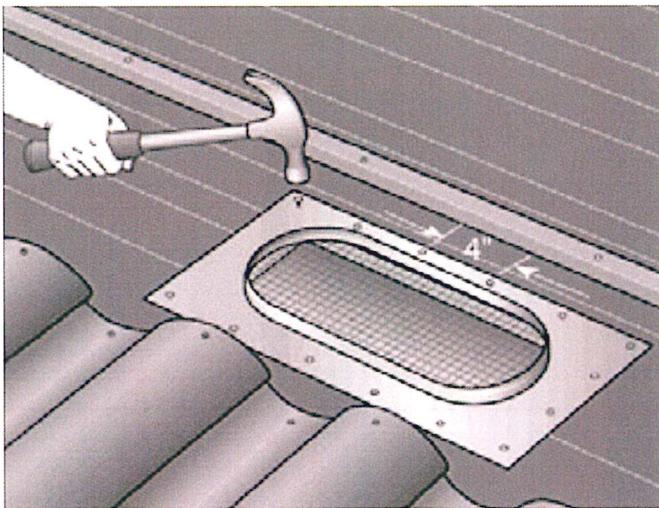

3. Attach at 4-inch centers using approved roofing Nails of sufficient length to penetrate the Sheathing.



4. Flash using locally approved peel and stick.



## S-TILE VENT INSTALLATION

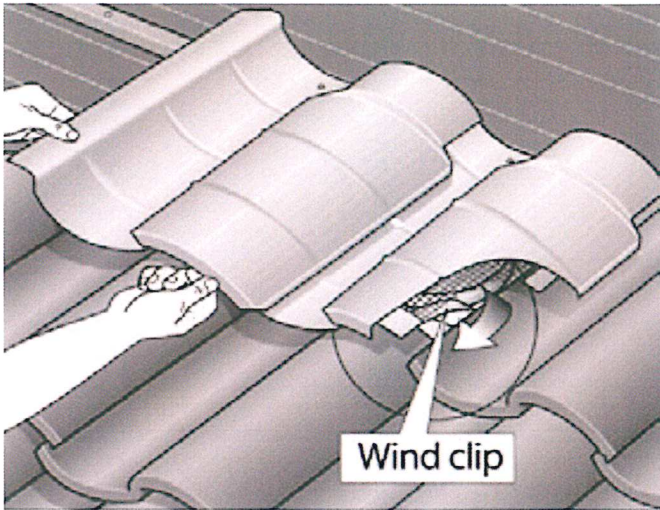

1. Install secondary vent cover, bending the Wind clip tightly under the preceding course Of tile, adjusting for head lap.

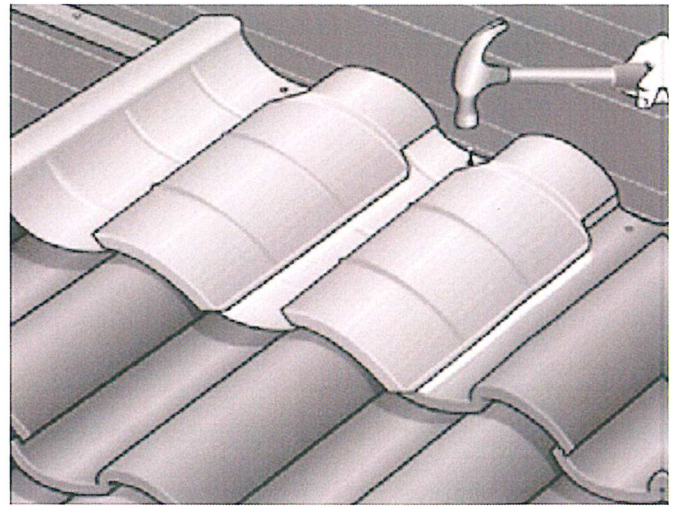

2. Secure with approved roofing nails of sufficient length to penetrate the Sheathing.

## M-TILE VENT INSTALLATION

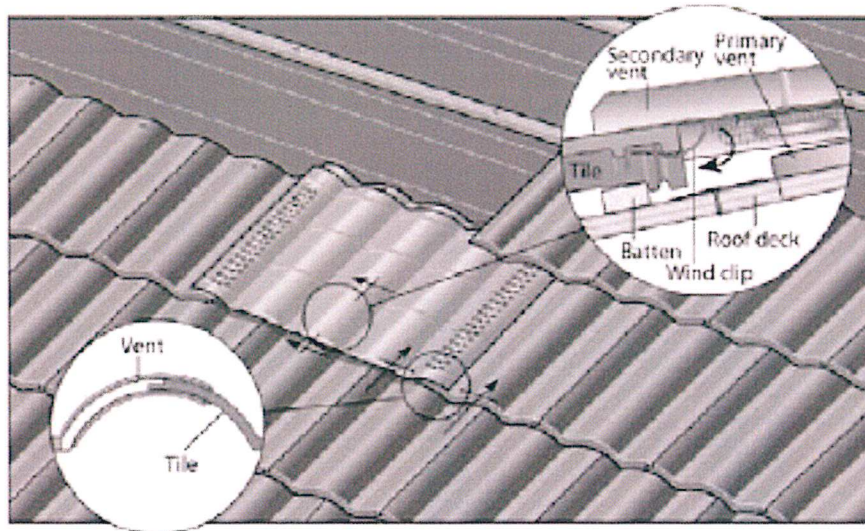

1. Tile is inserted between perforated top of secondary vent cover and bottom flanged with water channel. Bend the wind clip tightly under the preceding course of tile, asjusting for head lap. The secondary vent cover takes the place of two field tiles.

## FLAT-TILE VENT INSTALLATION

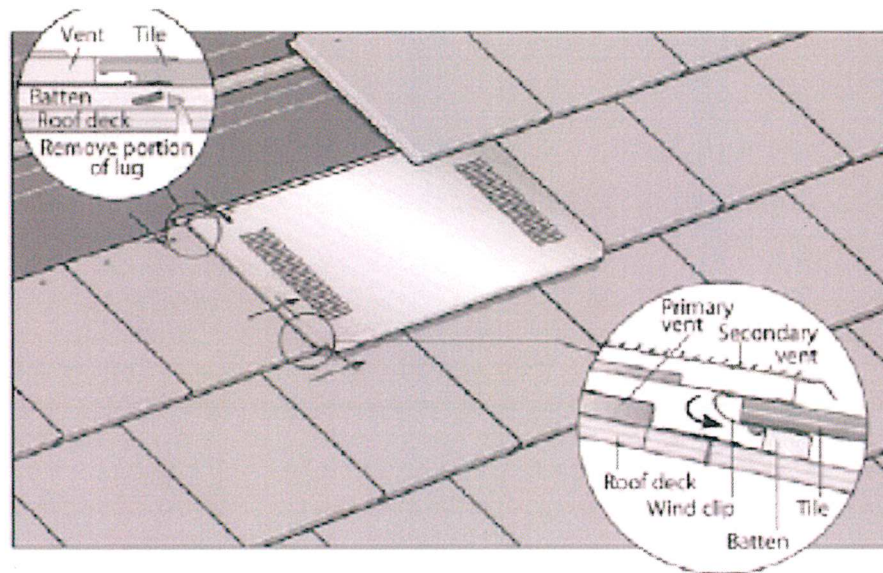

**1. Tile is inserted between louvered top of secondary vent cover and bottom flanged with water channel. Bend the wind clip tightly under the preceding course of tile, adjusting for head lap. Remove 2 to 3 inches of the tile batten lug on either side of the secondary vent cover for proper fit. For tiles with continuous lugs, a portion of the lug may be removed as needed for wind clip installation. The secondary vent cover takes the place of two field tiles.**



# DETAIL "B"

## M-Profile

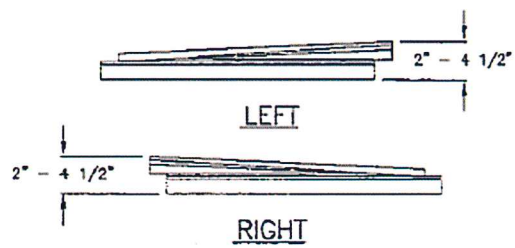
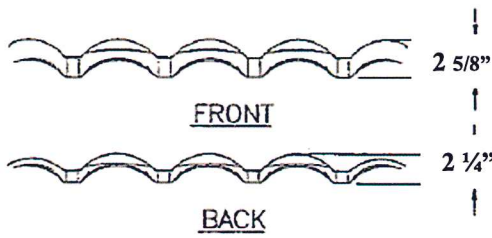
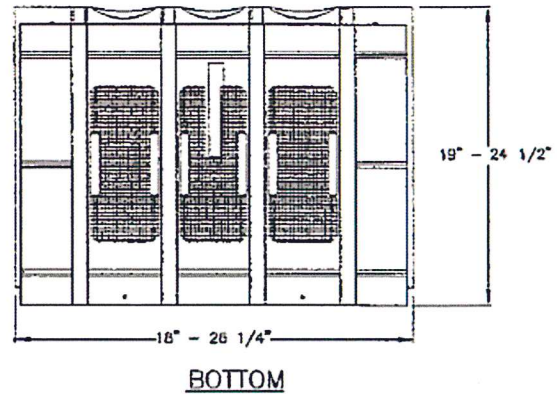
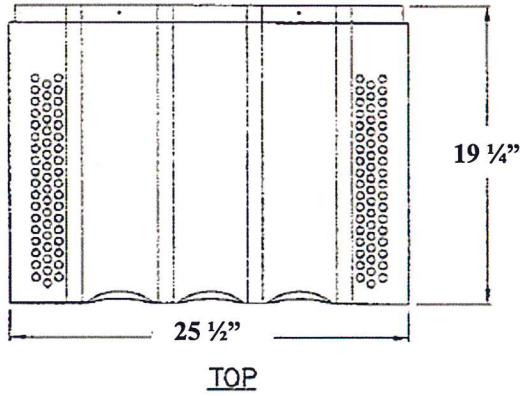

## S-PROFILE

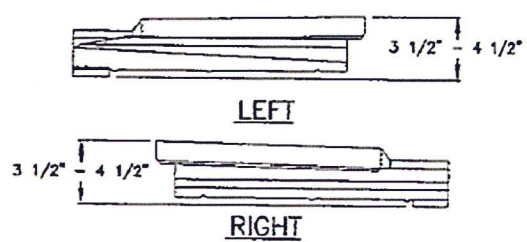
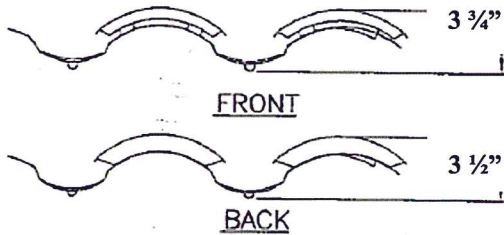
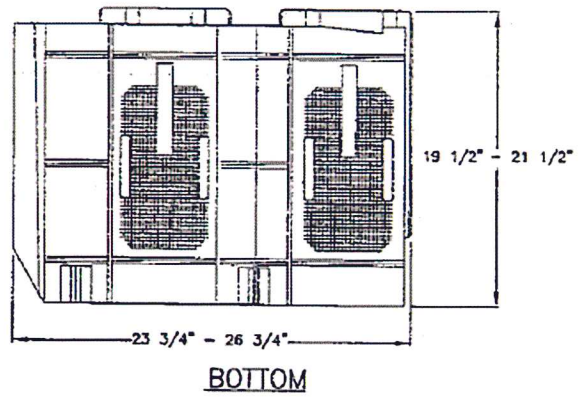
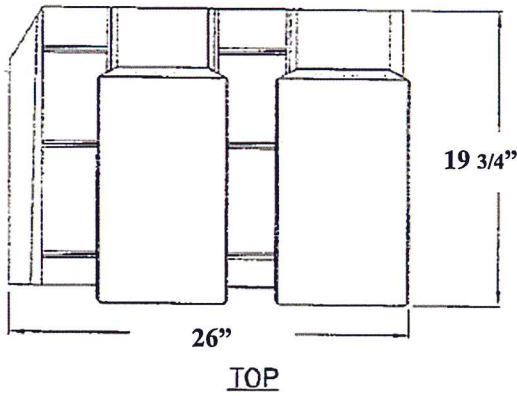

**FLAT-PROFILE**

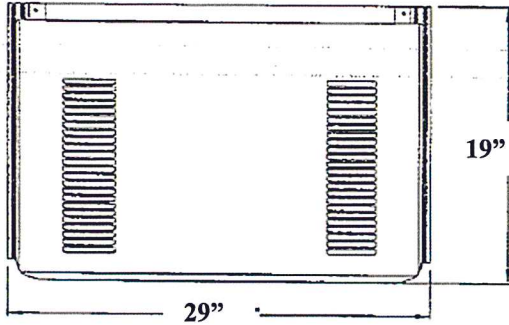

TOP



FRONT



BACK

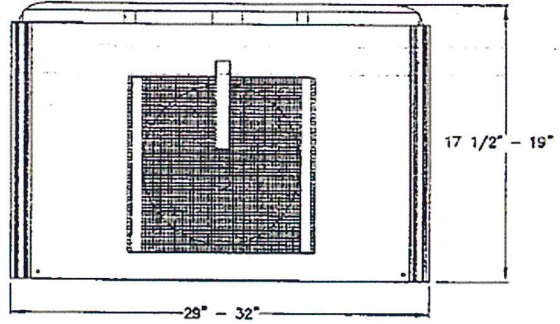

BOTTOM

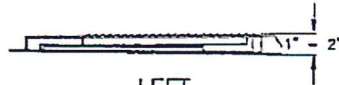

LEFT

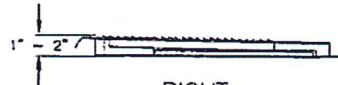

RIGHT





**PRIMARY VENT DETAIL**

STANDARD FLANGE

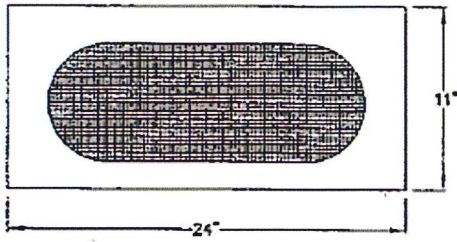

TOP

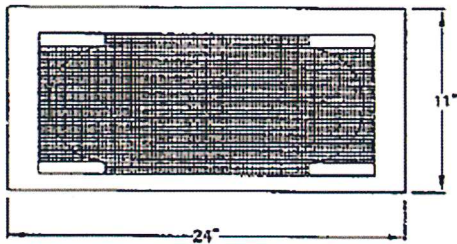

BOTTOM

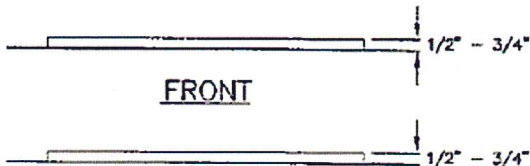

FRONT

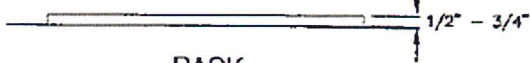

BACK



LEFT



RIGHT

DIVERTER FLANGE

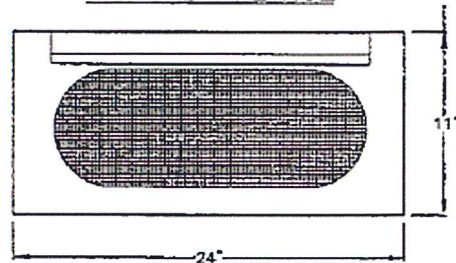

TOP

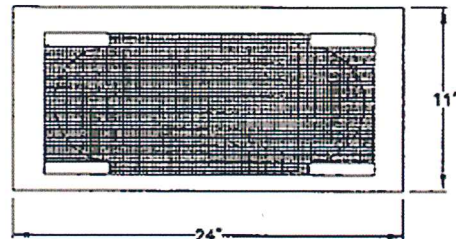

BOTTOM

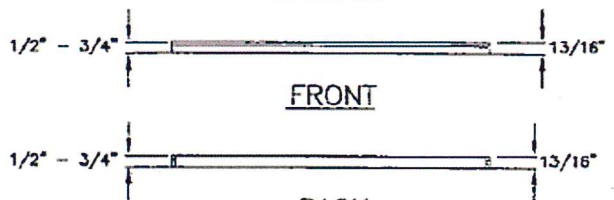

FRONT

BACK

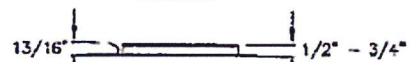

LEFT

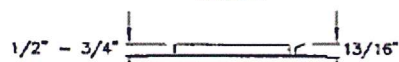

RIGHT

**END OF THIS ACCEPTANCE**

